

正面図

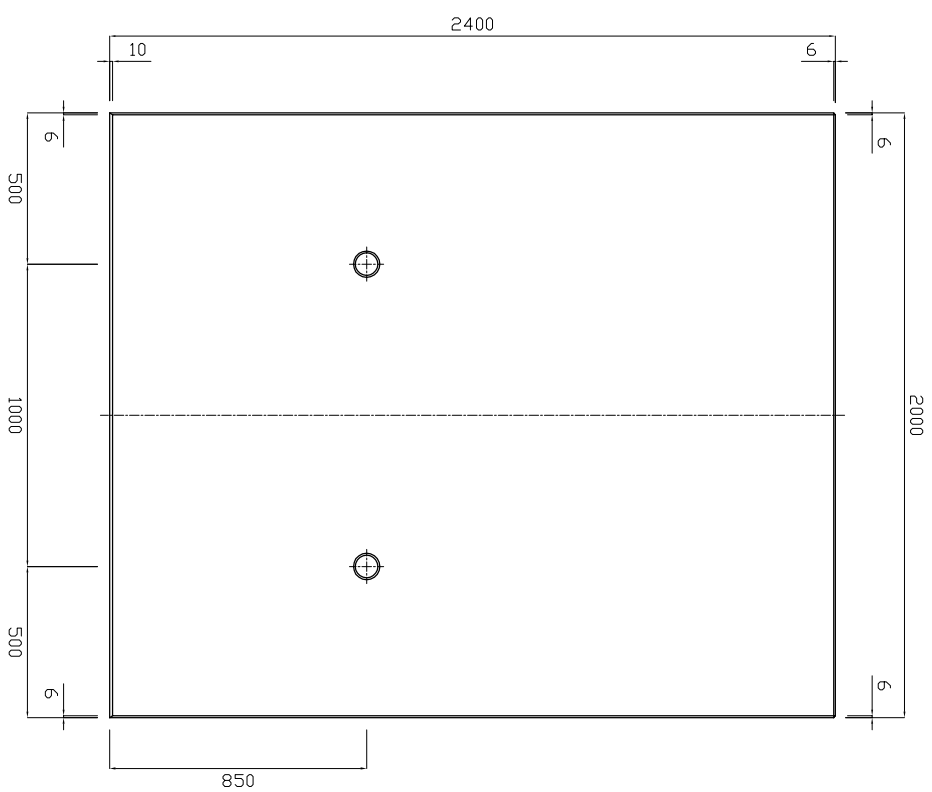

断面図

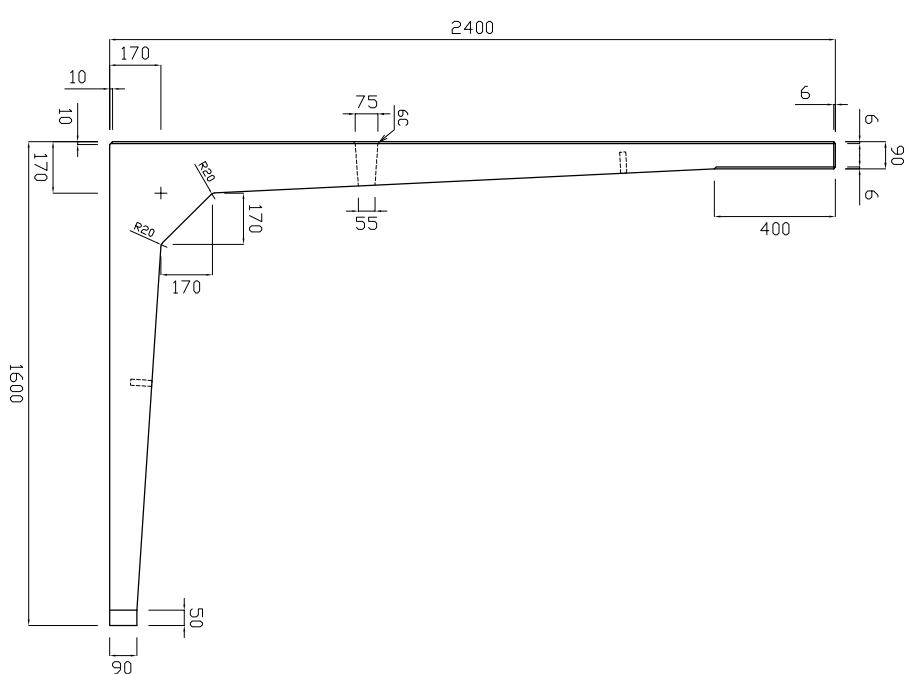

背面図

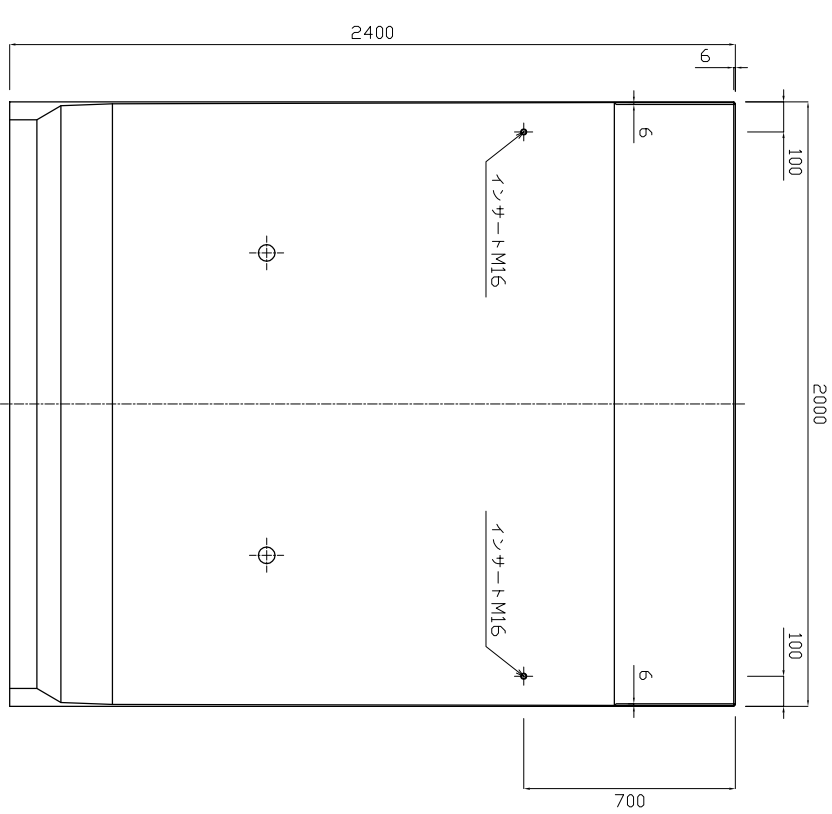

底面図

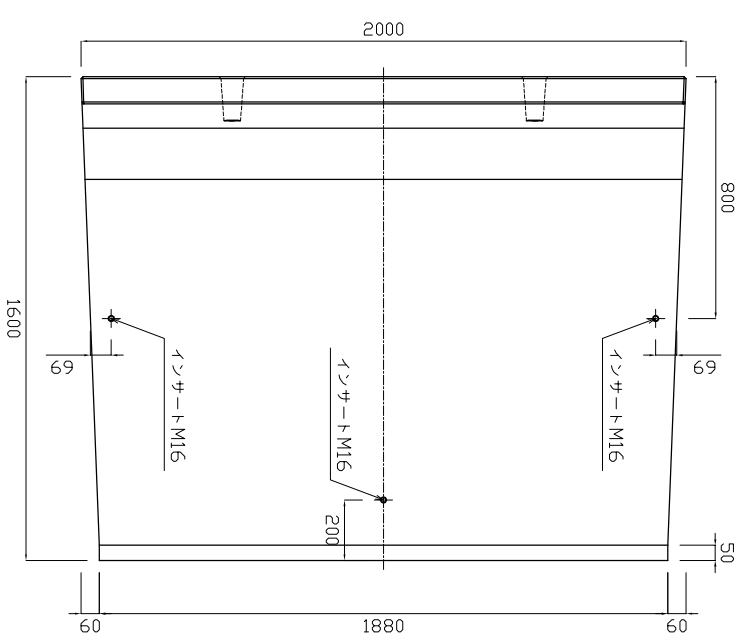

参考重量2420kg

製品名	L型擁壁 直角 3.5kN	縮尺	1 : 25
規格	H=2400 B=1600 L=2000		



新生興産株式会社
SHINSEI KOSAN CO., LTD